

Specifications

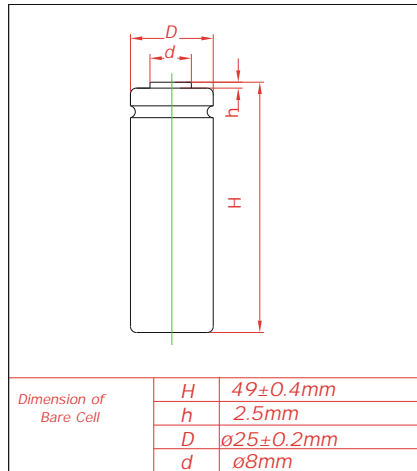

| | | | | |
|--|----------|---------------|------|---------|
| Nominal Capacity | | 2500mAh | | |
| Nominal Voltage | | 1.2V | | |
| Cycle life | | >500 | | |
| Charge | Standard | 250mA | 15h | 0-45°C |
| | Quick | 750mA | 5h | 5-45°C |
| | Fast | 2500mA | 1.1h | 10-45°C |
| Discharge | | -20°C~65-20°C | | |
| Storage | | | | |
| Internal Impedance(AC) (After Charge) | | 6m Ω | | |
| Weight | | 74g | | |

Charge

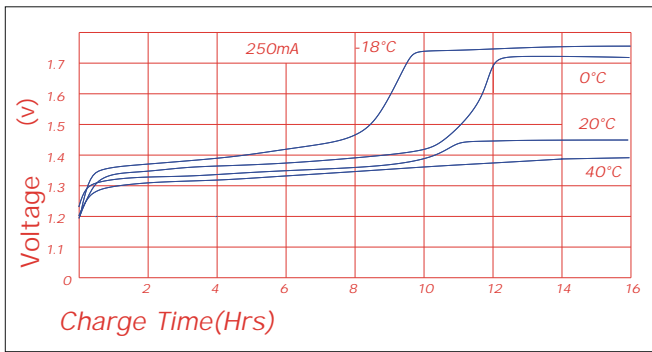

Discharge(at high rate)

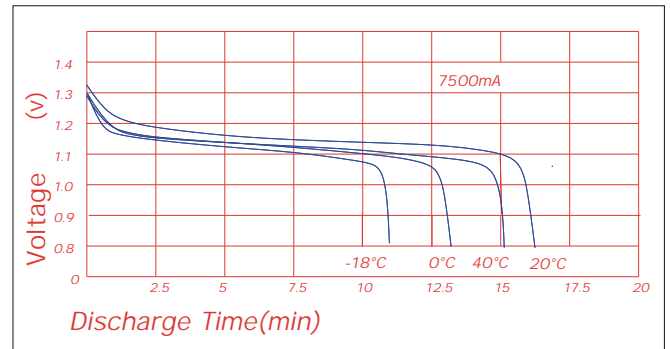

Discharge (at low rate)

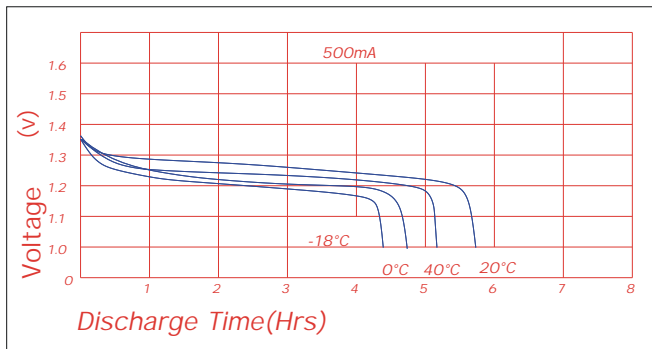

Discharge(at high rate)

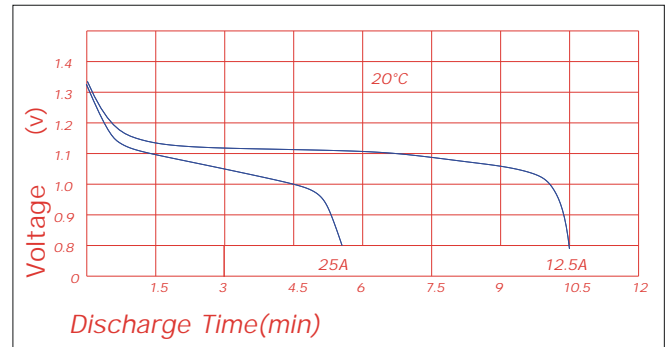

Discharge(at high rate)

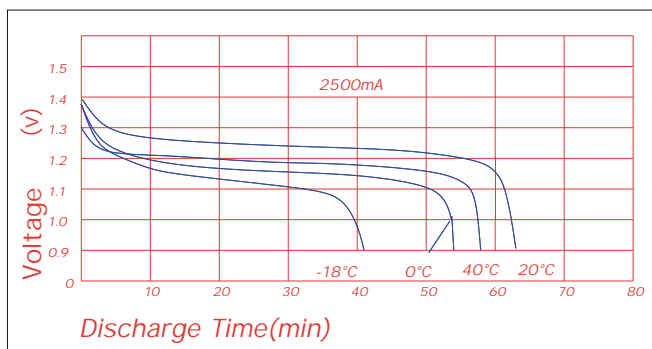

Charge Retention

